

ICOM[®]

INSTRUCTION MANUAL

VHF MARINE TRANSCEIVER

IC-M21

Icom Inc.

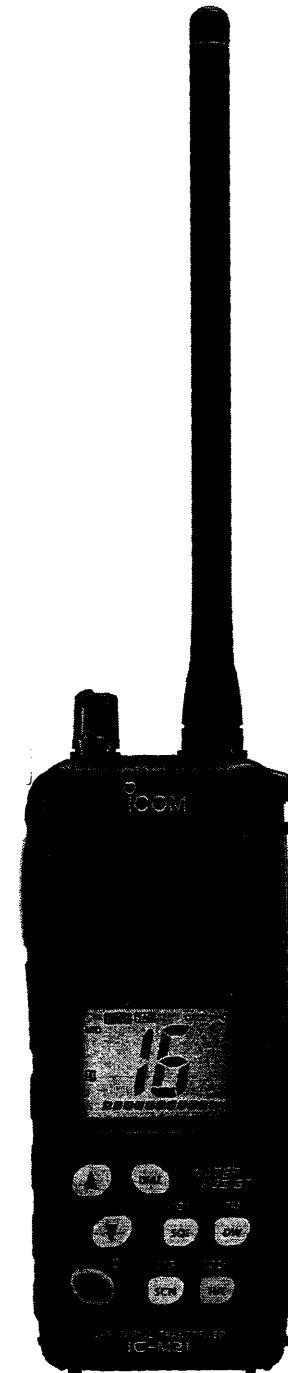

IN CASE OF EMERGENCY

If your vessel requires assistance, contact other vessels and the Coast Guard by sending a distress call on Channel 16.

○ **USING CHANNEL 16**

DISTRESS CALL PROCEDURE

1. "MAYDAY MAYDAY MAYDAY."
2. "THIS IS" (name of vessel)
3. Your call sign or other indication of the vessel.
4. "LOCATED AT" (your position)
5. The nature of the distress and assistance required.
6. Any other information which might facilitate the rescue.

RECOMMENDATION

CLEAN THE TRANSCEIVER THOROUGHLY WITH FRESH WATER after exposure to salt water.

Otherwise, the transceiver's keys, switches and controllers may become inoperable due to salt crystallization.





DECLARATION OF CONFORMITY

We Icom Inc. Japan
1-1-32 Kamiminami, Hirano-ku,
Osaka 547-0003 Japan

CE 0560!

Declare on our sole responsibility that this equipment complies with the essential requirements of the Radio and Telecommunications Terminal Equipment Directive, 1999/5/EC, and that any applicable Essential Test Suite measurements have been performed.

Düsseldorf 30th Nov. 2001
Place and date of issue

Kind of equipment: VHF MARINE TRANSCEIVER

Type-designation: IC-M21

Icom (Europe) GmbH
Himmelgeister straÙe 100
D-40225 Düsseldorf

Authorized representative name

Version (where applicable):

This compliance is based on conformity with the following harmonised standards, specifications or documents:

- | | | |
|------|-----------------------------|-----------------------------|
| i) | <u>EN 301 178-2</u> | <u>V1.1.1 (2000-08)</u> |
| ii) | <u>EN 60945</u> | <u>1997</u> |
| iii) | <u>EN 60950</u> | <u>1992</u> |
| iv) | <u>EN 300 698-2</u> | <u>V1.1.1 (2000-8)</u> |
| v) | <u> </u> | <u> </u> |
| vi) | <u> </u> | <u> </u> |

T. Maebayashi
General Manager

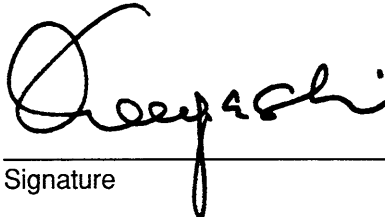
Signature

Icom Inc.

FOREWORD

Thank you for purchasing this Icom product. The IC-M21 VHF MARINE TRANSCEIVER is designed and built with Icom's superior technology and craftsmanship. With proper care this product should provide you with years of trouble-free operation.

IMPORTANT

READ ALL INSTRUCTIONS carefully and completely before using the transceiver.

SAVE THIS INSTRUCTION MANUAL—This instruction manual contains important operating instructions for the IC-M21.

EXPLICIT DEFINITIONS

WORD	DEFINITION
⚠ WARNING	Personal injury, fire hazard or electric shock may occur.
CAUTION	Equipment damage may occur.
NOTE	If disregarded, inconvenience only. No risk of personal injury, fire or electric shock.

FEATURES

👉 Water resistant construction

Built tough to withstand the punishing marine environment, the IC-M21 meets JIS water resistant specification grade 7 while using BP-223 or BP-224.

👉 Dual watch and tri-watch functions*

Convenient functions which allow you to monitor the distress channel (Ch 16) while receiving a channel of your choice—dual watch; or monitor the distress channel and another channel while receiving a channel of your choice—tri-watch.

*This function may not be available depending on version.

👉 Large, easy-to-read LCD

With dimensions of 24(H) × 35(W) mm, the IC-M21's function display is easy to read and shows operating conditions at a glance. Backlighting and contrast can be adjusted to suit your preferences.

👉 Simple operation

Ergonomic design with a minimum number of switches and controls provides simple intuitive operation.

CAUTIONS

⚠ WARNING! NEVER connect the transceiver to an AC outlet. This may pose a fire hazard or result in an electric shock.

⚠ WARNING! NEVER hold the transceiver so that the antenna is very close to, or touching exposed parts of the body, especially the face or eyes, while transmitting. The transceiver will perform best if the microphone is 5 to 10 cm (2 to 4 inches) away from the lips and the transceiver is vertical.

NEVER connect the transceiver to a power source other than the BP-223 or BP-224. Such a connection will ruin the transceiver.

AVOID using or placing the transceiver in direct sunlight or in areas with temperatures below -15°C or above $+55^{\circ}\text{C}$.

KEEP the transceiver out of the reach of children.



KEEP the transceiver at least 0.9 meter (3.0 ft) away from your vessel's magnetic navigation compass.

Icom, Icom Inc. and  ICOM are registered trademarks of Icom Incorporated (Japan) in the United States, United Kingdom, Germany, France, Spain, Russia and/or other countries.

BE CAREFUL! The transceiver's right-side panel will become hot when operating continuously for long periods.

BE CAREFUL! The IC-M21 employs water resistant construction, which corresponds to JIS water resistant specification, grade 7 (1 m; 3 ft depth for 30 min.). However, once the transceiver has been dropped, water resistant cannot be guaranteed due to the fact that the transceiver may be cracked, or the water resistant seal damaged, etc.

MAKE SURE the flexible antenna and battery pack are securely attached to the transceiver, and that the antenna and battery pack are dry before attachment. Exposing the inside of the transceiver to water will result in serious damage to the transceiver.

  Versions of the IC-M21 which display the "CE" symbol on the serial number seal, comply with the essential requirements of the European Radio and Telecommunication Terminal Directive 1999/5/EC.

 This warning symbol indicates that this equipment operates in non-harmonised frequency bands and/or may be subject to licensing conditions in the country of use. Be sure to check that you have the correct version of this radio or the correct programming of this radio, to comply with national licensing requirement.

TABLE OF CONTENTS

IN CASE OF EMERGENCY	i
RECOMMENDATION	i
FOREWORD	ii
IMPORTANT	ii
EXPLICIT DEFINITIONS	ii
FEATURES	ii
CAUTIONS	iii
TABLE OF CONTENTS	iv
1 OPERATING RULES	1
2 PANEL DESCRIPTION	2-5
■ Front, top and side panels.....	2
■ Function display	4
3 BASIC OPERATION	6-9
■ Channel selection	6
■ Lock function	7
■ Adjusting the squelch level	7
■ Receiving and transmitting	8
■ Call channel programming	9
■ Automatic backlighting	9
4 DUALWATCH/TRI-WATCH	10
■ Description	10
■ Operation	10

5 SCAN OPERATION	11-12
■ Scan types	11
■ Setting tag channels	12
■ Starting a scan	12
6 SET MODE	13-16
■ SET mode programming	13
■ SET mode items	13
7 BATTERY CHARGING	17-19
■ Battery charging	17
■ Battery cautions	17
■ Installing batteries in the battery case	18
■ Optional battery chargers	19
8 SUPPLIED ACCESSORIES AND ATTACHMENTS	20-22
9 TROUBLESHOOTING	23
10 CHANNEL LIST	24
11 SPECIFICATIONS AND OPTIONS	25
■ Specifications	25
■ Options	25

DECLARATION OF CONFORMITY

◇ **Priorities**

- Read all rules and regulations pertaining to priorities and keep an up-to-date copy handy. Safety and distress calls take priority over all others.
- You must monitor Channel 16 when you are not operating on another channel.
- False or fraudulent distress calls are prohibited under law.

◇ **Privacy**

- Information overheard but not intended for you cannot lawfully be used in any way.
- Indecent or profane language is prohibited.

◇ **Radio licenses**

(1) SHIP STATION LICENSE

When your craft is equipped with a VHF FM transceiver, you must have a current radio station license before using the transceiver. It is unlawful to operate a ship station which is not licensed.

Inquire through your dealer or the appropriate government agency for a Ship-Radiotelephone license. This license includes the call sign which is your craft's identification for radio purposes.

(2) OPERATOR'S LICENSE

A restricted Radiotelephone Operator Permit is the license most often held by small vessel radio operators when a radio is not required for safety purposes.

The Restricted Radiotelephone Operator Permit must be posted near the transceiver or be kept with the operator. Only a licensed radio operator may operate a transceiver.

However, non-licensed individuals may talk over a transceiver if a licensed operator starts, supervises, ends the call and makes the necessary log entries.

A current copy of the applicable government rules and regulations is only required to be on hand for vessels in which a radio telephone is compulsory. However, even if you are not required to have these on hand it is your responsibility to be thoroughly acquainted with all pertinent rules and regulations.

■ Front, top and side panels

① DIAL/CHANNEL GROUP SWITCH [DIAL]

- Selects and changes the regular channels. (p. 6)
- Selects one of 2 regular channels in sequence when pushed for 1 sec. (p. 6)
 - International and U.S.A. (U.K. version only) channels* are available for regular channels.
 - *Germany version is International and ATIS channels.

② CHANNEL UP/DOWN SWITCHES [▲]/[▼]

- Select an operating channel.
- Selects the SET mode condition of the item. (p. 13)
- Set the squelch level in the squelch set mode. (p. 7)

③ CHANNEL 16 SWITCH [16•C]

- Selects Channel 16 when pushed. (p. 6)
- Selects the call channel when pushed for 1 sec.
- Enters call Channel write mode when the call channel is selected and this switch is pushed for 3 sec. (p. 9)

④ SCAN/TAG SWITCH [SCN•TAG] (p. 12)

- Starts and stops normal or priority scan.
- Sets and clears the displayed channel as a tag (scanned) channel when pushed for 1 sec.

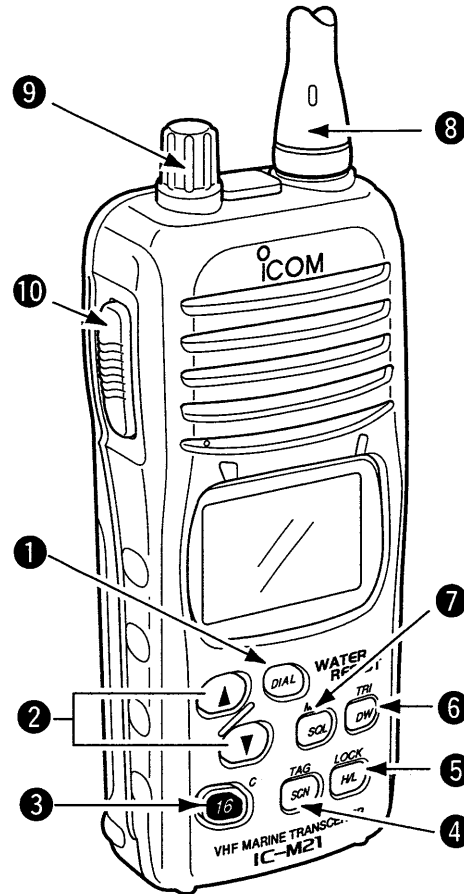

⑤ TRANSMIT POWER/LOCK SWITCH [H/L•LOCK]

- Selects high, middle or low power when pushed. (p. 8)
- Toggles the lock function ON/OFF when pushed for 1 sec. (p. 7)

⑥ DUALWATCH/TRI-WATCH SWITCH [DW•TRI] (p. 10)

- Starts dualwatch when pushed momentarily.
- Starts tri-watch when pushed for 1 sec.
- Stops dualwatch/tri-watch when either is activated.

⑦ SQUELCH SWITCH [SQL•MONI] (p. 7)

- Push this switch, then set the squelch level with [▲]/[▼].
- Manually opens the squelch for channel monitoring when pushed for 1 sec.

⑧ ANTENNA (p. 20)

Connects the supplied antenna.

⑨ VOLUME CONTROL [OFF/VOL]

Turns power ON and adjusts the audio level.

⑩ PTT SWITCH [PTT]

Push and hold to transmit; release to receive.

2 PANEL DESCRIPTION

◇ BATTERY CASE RELEASE SCREW

To remove the battery case:

Turn the screw counterclockwise, then pull the battery pack in the direction of the arrow as shown below.

To attach the battery case:

Insert the battery case in the IC-M21 completely, then turn the screw clockwise.

NOTE: When removing or attaching the battery case, use a coin or flat-head screwdriver to loosen or tighten the bottom screw.

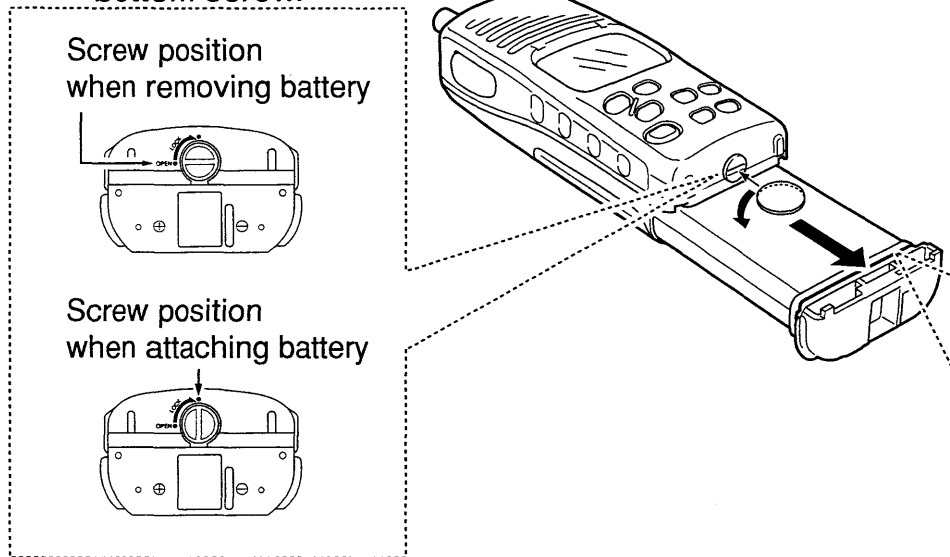

CAUTION!:

When attaching or releasing a battery pack, make sure the rubber seal is set in the groove of the battery pack/case correctly. If the seal is not neatly in the groove it may be damaged when attaching the battery pack/case. If the seal is damaged, water resistant is not guaranteed.

NOTE:

When attaching a battery pack/case, make sure dust etc. does not adhere to the rubber seal. If dust etc. is on the seal when attaching a battery pack/case, the water resistant may be reduced.

Make sure both the rubber seal (purple) is set to the groove correctly and dust etc. does not adhere to it.

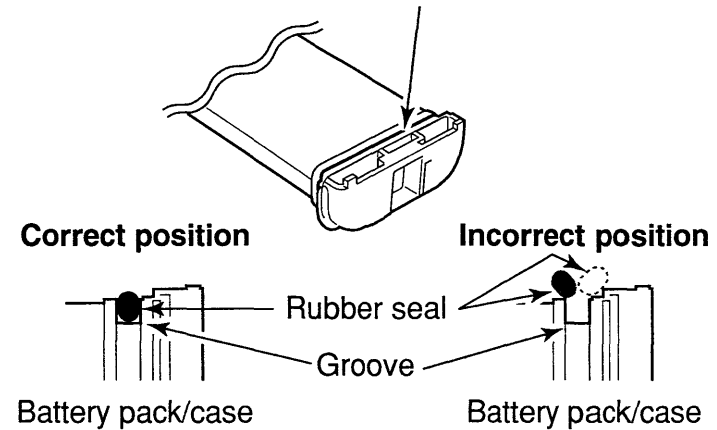

■ Function display

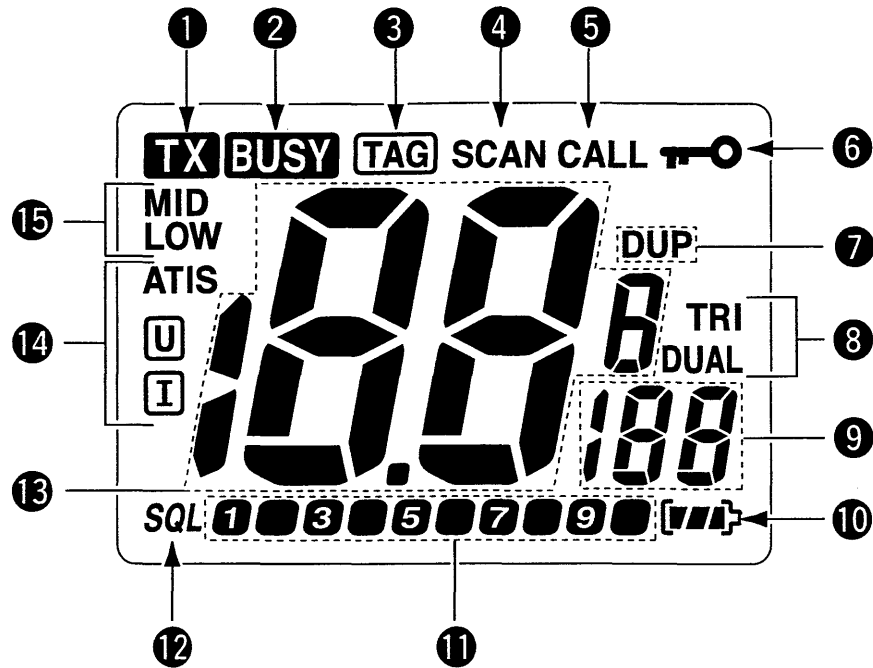

- 1 TRANSMIT INDICATOR** (p. 8)
Appears while transmitting.
- 2 BUSY INDICATOR** (p. 8)
Appears when receiving a signal or when the squelch opens.
- 3 TAG CHANNEL INDICATOR** (p. 12)
Appears when a tag channel is selected.
- 4 SCAN INDICATOR** (p. 12)
Blinks while scanning.
- 5 CALL CHANNEL INDICATOR** (p. 6)
Appears when the call channel is selected.
- 6 LOCK INDICATOR** (p. 7)
Appears while the lock function is activated.
- 7 DUPLEX INDICATOR**
Appears when a duplex channel is selected.
- 8 DUALWATCH/TRI-WATCH INDICATORS** (p. 10)
“DUAL” appears during dualwatch; “TRI” appears during tri-watch.





2 PANEL DESCRIPTION

9 SUB CHANNEL READOUT

- Indicates Channel 16 during priority scan.
- Indicates Channel 16 during dualwatch or tri-watch. (p. 10)
- Indicates the SET mode item while in SET mode

10 BATTERY INDICATOR

Indicates remaining battery power.

Indication				
Battery level	Full	Middle	Charging required	No battery

11 SQUELCH LEVEL INDICATOR (p. 7)

Shows squelch level when set.

This indicator can be also used as an S/RF meter when the S/RF meter indicator setting is ON. (p. 16)



12 SQUELCH LEVEL ADJUSTING INDICATOR (p. 7)

Appears while adjusting the squelch level.

13 CHANNEL NUMBER READOUT

- Indicates the selected operating channel number.
- In SET mode, indicates the selected condition.

14 CHANNEL GROUP INDICATOR (p. 6)

“” appears when International; “” appears when U.S.A. (U.K. and Italian versions only); “ATIS” appears when ATIS function is activated (Germany version only).

15 TRANSMIT POWER INDICATOR

- “LOW” appears when low power is selected. (p. 8)
- “LOW” blinks when switching forced low power mode because of a high temperature error or low voltage.
- “MID”* appears when middle power is selected. (p. 8)
*Except Germany version.
- No indicator appears when high power is selected.

■ Channel selection

◇ Channel 16

Channel 16 is the distress channel. It is used for establishing initial contact with another station and for emergency communications. Channel 16 is monitored during dualwatch or tri-watch. While standing by you are required to monitor Channel 16.

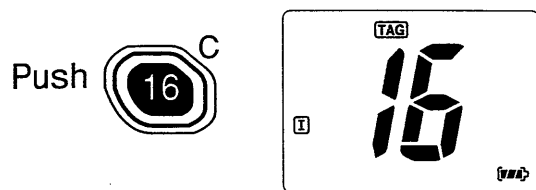

◇ Call channel

Each regular channel group has a separate call channel. The call channel is monitored during tri-watch. The call channels can be programmed (p. 9) and are used to store your most often-used channels in each channel group for quick recall.

• Push [16•C] for 1 sec. to select the call channel for the selected channel group.

- "CALL" and call channel number appear.

- Each channel group can have its own call channel when programmed.

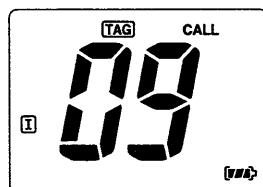

◇ International and U.S.A. channels

There are 57 International and 57 U.S.A. channels. These channel groups may be specified for the operating area.

- ① Push [DIAL] to select a regular channel.
- ② Push [▲]/[▼] switches to select a channel.
 - "DUP" appears for duplex channels.
- ③ To change the channel group, push [DIAL] for 1 sec.
 - International and U.S.A. channels can be selected in sequence.

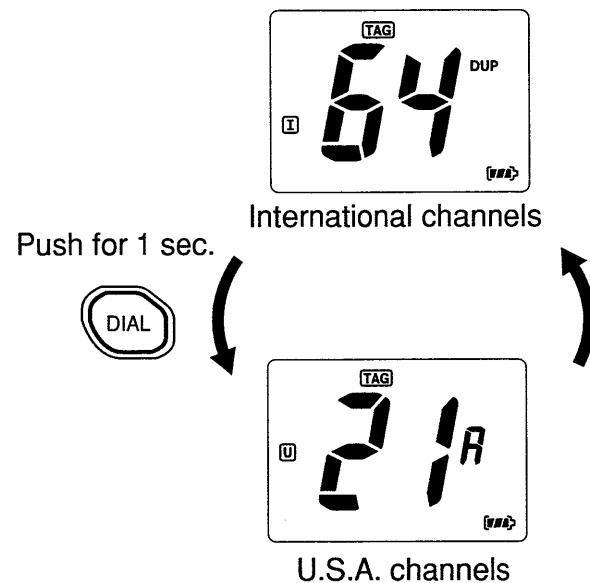

■ Lock function

This function electronically locks all keys, except [PTT], [SQL•MONI] and [H/L•LOCK] to prevent accidental channel changes and function access.

- Push [H/L•LOCK] for 1 sec. to turn the lock function ON and OFF.
 - Only [PTT], [H/L•LOCK] and [SQL•MONI] are functional.

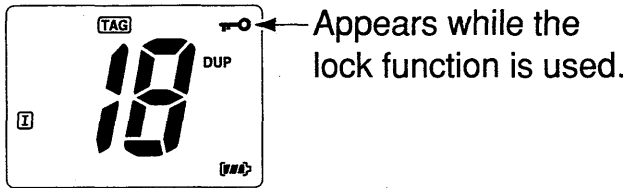

■ Adjusting the squelch level

The IC-M21 has a squelch even though there is no control knob for it. In order to receive signals properly, as well as for scan to function, the squelch must be adjusted to a suitable level.

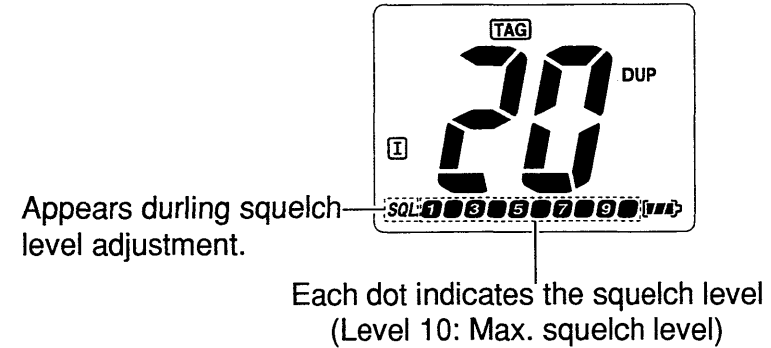

- ① Push [SQL•MONI], then adjust the squelch level with [▲]/[▼].
 - “SQL” indicator and squelch level indicator appear.
 - There are 11 squelch levels to choose from: 0 is completely open; 10 is the maximum squelch level.
 - When no keys are pushed for 5 sec., the transceiver returns to normal condition.
- ② Push [SQL•MONI] again to return to normal condition.

■ Receiving and transmitting

CAUTION: Transmitting without an antenna may damage the transceiver.

- ① Rotate [OFF/VOL] clockwise to turn power ON.
 - Use the squelch function to mute any audio noise if necessary. Refer to the previous page for details.
- ② Push* [SQL•MONI] for 1 sec., and rotate volume to set audio output level.
 - *According to Monitor action selection in SET mode (p. 14).
- ③ Push [▲]/[▼] to select the desired channel.
 - When receiving a signal, "BUSY" appears and audio is emitted from the speaker.
 - (The S/Rf meter appears while S/Rf meter turned ON in SET mode.)
 - Further adjustment of [OFF/VOL] may be necessary at this point.
- ④ Push [H/L] to select the output power if necessary.
 - "LOW" appears when low power is selected; "MID" appears when middle power is selected; no indicator appears when high power is selected.
 - Choose low power to conserve battery power, choose high power for longer distance communications.
 - Some channels are for low power only.
- ⑤ Push and hold [PTT] to transmit, then speak into the microphone.
 - "TX" appears.
 - (The S/Rf meter appears while S/Rf meter is turned ON in SET mode.)
 - Channel 70 cannot be used for transmission (for GMDSS use).
- ⑥ Release [PTT] to receive.

IMPORTANT: To maximize the readability of your transmitted signal, pause a few sec. after pushing [PTT], hold the microphone 5 to 10 cm (2 to 4 inches) from your mouth and speak at a normal voice level.

NOTE: The transceiver has a power save function to conserve the battery power and cannot be turned OFF. The power save function activates automatically when no signal is received for 5 sec.

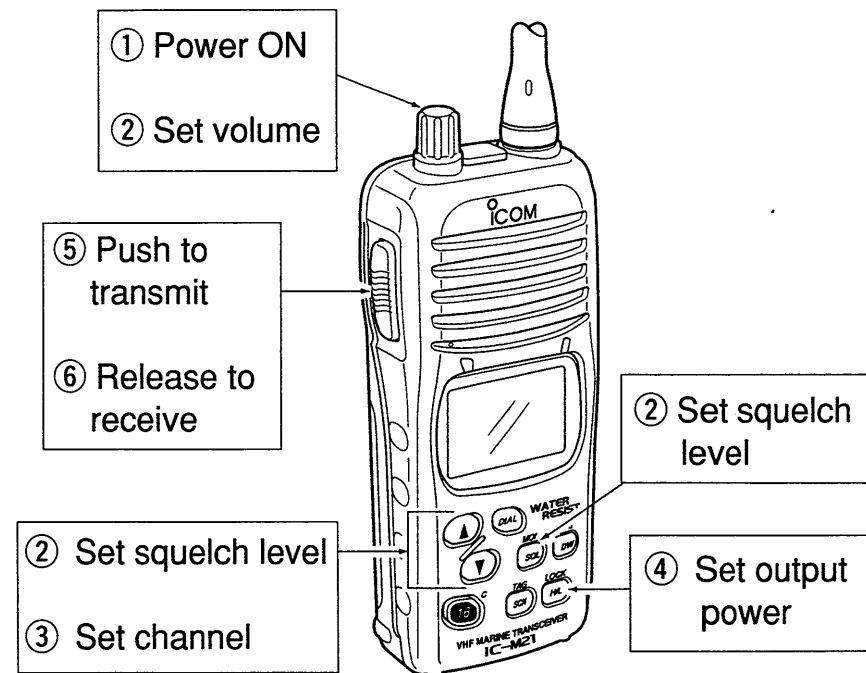

■ Call channel programming

The call channel switch is used to select Channel 9 by default, however, you can program your most often-used channels in each channel group for quick recall.

- ① Push [DIAL] for 1 sec. to select the desired channel group (INT, USA) to be programmed.

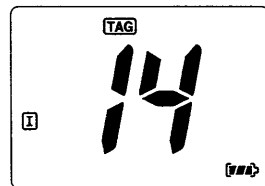

- ② Push [16•C] for 1 sec. to select the call channel of the selected channel group.
- "CALL" and call channel number appear.

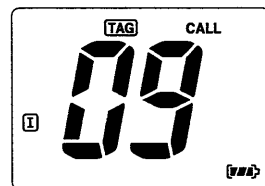

- ③ Push [16•C] again for 3 sec. (until long beep changes to 2 short beeps) to enter call channel programming condition.
- Call channel number and channel group to be programmed flash.

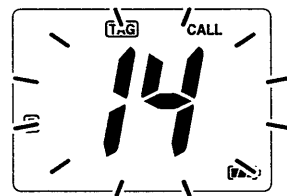

- ④ Push [▲]/[▼] to select the desired channel.

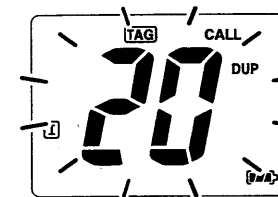

- ⑤ Push [16•C] to program the displayed channel as the call channel.
- The call channel number and channel group stop flashing.

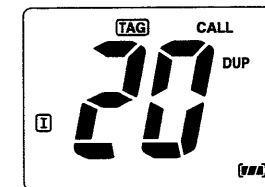

■ Automatic backlighting

This function is convenient for nighttime operation. The automatic backlighting can be deactivated in SET mode. (p. 14)

- Push any key except for [PTT] to turn the backlighting ON.
- The backlighting is automatically turned OFF after 5 sec. of inactivity.

■ Description

Dualwatch monitors Channel 16 while you are receiving another channel; tri-watch monitors Channel 16 and the call channel while receiving another channel.

DUALWATCH/TRI-WATCH SIMULATION

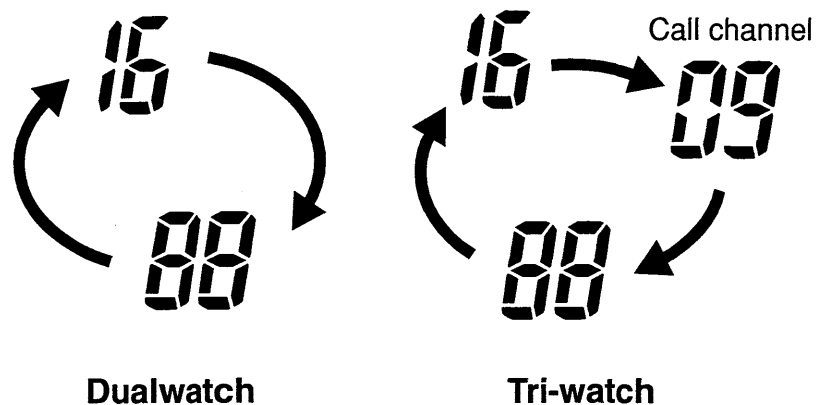

- If a signal is received on Channel 16, dualwatch/tri-watch pauses on Channel 16 until the signal disappears.
- If a signal is received on the call channel during tri-watch, tri-watch becomes dualwatch until the signal disappears.
- To transmit on the selected channel during dualwatch/tri-watch, push and hold [PTT].

■ Operation

- ① Select the desired operating channel.
- ② Push [DW•TRI] momentarily to start dualwatch; push [DW•TRI] for 1 sec. to start tri-watch.
 - "DUAL" flashes during dualwatch; "TRI" flashes during tri-watch.
 - BEEP tones sound when a signal is received on Channel 16.
 - Tri-watch becomes dualwatch when receiving a signal on the call channel.
- ③ To cancel dualwatch/tri-watch, push [DW•TRI] again.

[Example]: Operating tri-watch on INT Channel 07.

Push for 1 sec.

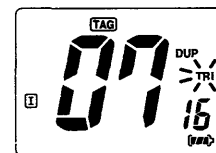

Tri-watch starts.

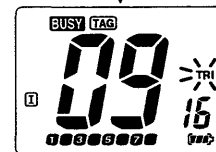

Signal is received on call channel.

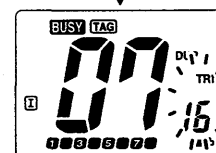

Signal received on Channel 16 takes priority.

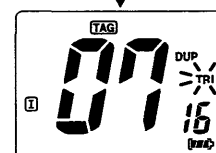

Tri-watch resumes after the signal disappears.

■ Scan types

Scanning is an efficient way to locate signals quickly over a wide frequency range. The transceiver has a priority scan and a normal scan.

Set the tag channels (channels to be scanned) before scanning. Clear the tag channels which inconveniently stop scanning, such as those used for digital communications.

/// **NOTE:** Choose priority or normal scan in SET mode. (p. 13)

PRIORITY SCAN

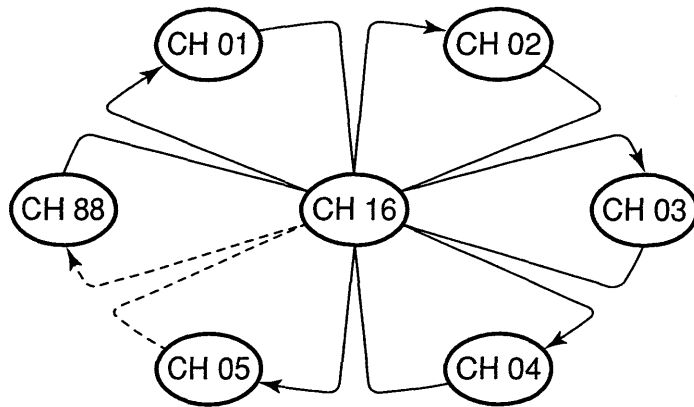

Priority scan searches through all tag channels in sequence while monitoring Channel 16. When a signal is detected on Channel 16, scan pauses until the signal disappears; when a signal is detected on a channel other than Channel 16, scan becomes dualwatch until the signal disappears.

NORMAL SCAN

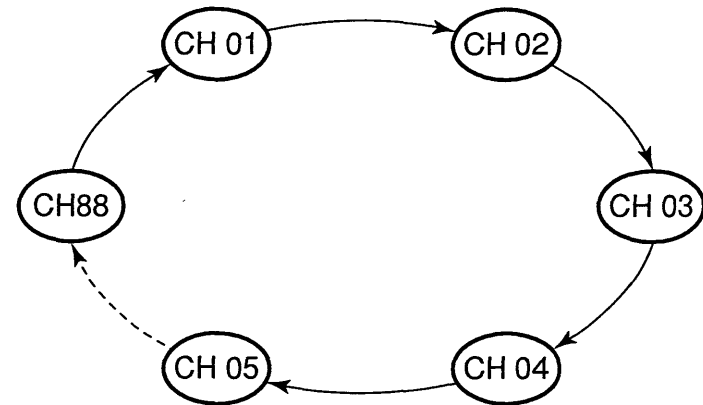

Normal scan, like priority scan, searches through all tag channels in sequence. However, unlike priority scan, Channel 16 is not checked unless Channel 16 is set as a tag channel.

■ Setting tag channels

For more efficient scanning, add desired channels as tag channels or clear tag channels for unwanted channels. Channels set as non-tag channels will be skipped during scanning. Tag channels can be assigned to each channel group (INT, USA) independently.

- ① Select the desired channel group (INT, USA) by pushing [DIAL] for 1 sec., if desired.
- ② Select the desired channel to set as a tag channel.
- ③ Push [SCN•TAG] for 1 sec. to set the displayed channel as a tag channel.
 - "TAG" appears in the function display.
- ④ To cancel the tag channel setting, push [SCN•TAG] for 1 sec.
 - "TAG" disappears.

• Clearing all tag channels in the selected channel group

While pushing [SCN•TAG], turn the power ON to clear all tag channels in the channel group.

■ Starting a scan

Set scan type and scan resume timer in advance using SET mode. (pgs. 13, 14)

- ① Select the desired channel group (INT, USA) by pushing [DIAL] for 1 sec., if desired.
- ② Push [SCN•TAG] to start priority or normal scan.
 - "SCAN" blinks in the function display.
 - "16" appears during priority scan.
 - When a signal is detected, scan pauses until the signal disappears or resumes after pausing 5 sec. according to SET mode setting. (Channel 16 is still monitored during priority scan.)
 - Push [▲]/[▼] to check tag channels, to change the scanning direction or resume the scan manually.
- ③ To stop the scan, push [SCN•TAG].
 - "SCAN" disappears.
 - Pushing [PTT], [16•C], [DIAL] or [DW•TRI] also stops the scan.

[Example]: Starting a normal scan.

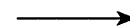
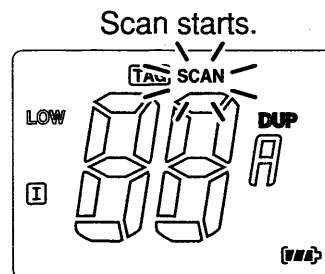
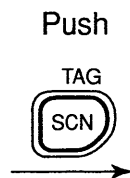
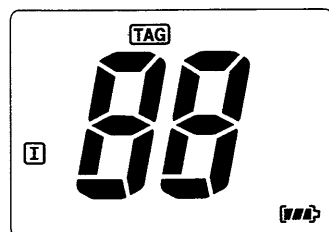

Scan pauses when receiving a signal and audio is emitted.

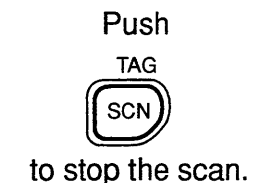
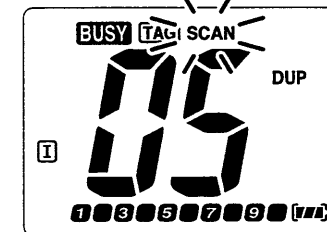

■ SET mode programming

SET mode is used to change the conditions of 11 transceiver functions: beep tone, scan type, scan resume timer, auto scan, monitor action, automatic backlighting, LCD contrast, auto power save, self check, battery voltage and S/RF meter.

- ① Turn power OFF.
- ② While pushing [SQL•MONI], turn power ON and continue pushing [SQL•MONI] until "bP" appears.
- ③ Release [SQL•MONI].
- ④ Push [▲]/[▼] to select the desired condition of the item.
- ⑤ Push [SQL•MONI] to select the desired item, if necessary.
- ⑥ To exit SET mode, turn the power OFF, then ON again, or push [16•C].

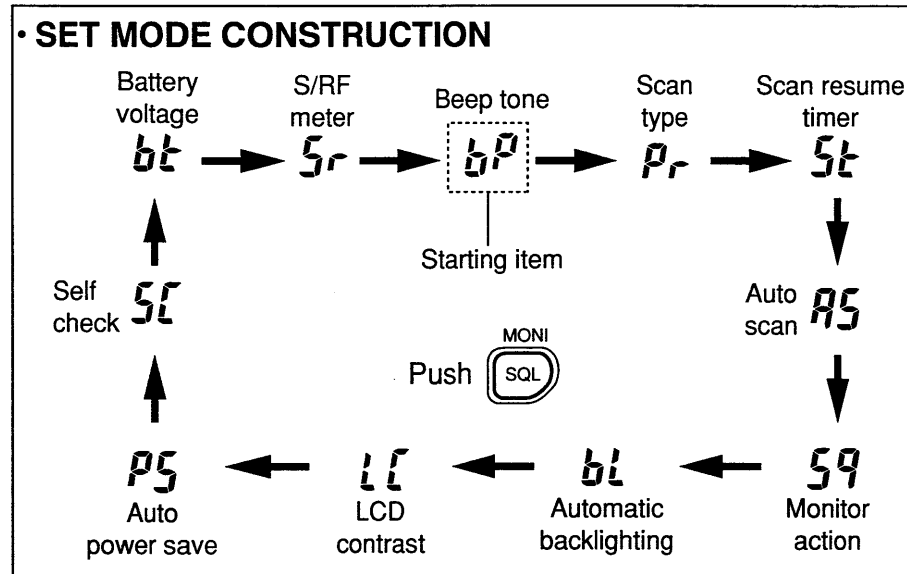

■ SET mode items

◇ Beep tone "bP"

You can select silent operation by turning beep tones OFF or you can have confirmation beeps sound at the push of a switch by turning beep tones ON.

- AUTO (At): Beep tone is linked with volume tone.
- 1–10: Beep tone scale is set from 1–10 scale (Max. is 10).

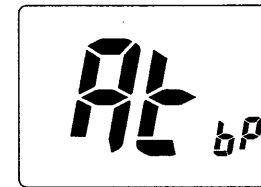

Beep tone AUTO (default)

◇ Priority scan function "Pr"

The transceiver has 2 scan types. Normal scan and priority scan. Normal scan searches all tag channels in the selected channel group. Priority scan searches all tag channels in sequence while monitoring Channel 16.

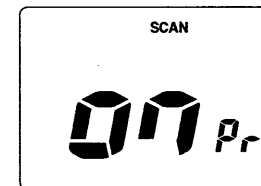

Priority scan (default)

◇ Scan resume timer “St”

The scan resume timer can be selected as a pause (OFF) or timer scan (ON). When OFF is selected, the scan pauses until a received signal disappears. When ON is selected, the scan pauses for 5 sec. after receiving a signal and then resumes even if the signal is still being received.

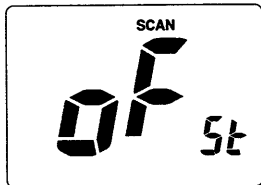

Scan timer OFF (default)

◇ Auto scan function “AS”

While in standby, this function automatically starts the desired scan (normal or priority scan) 30 sec. after operation.

- Scan indicator blinks while scanning.

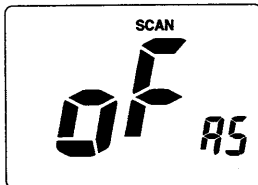

Auto scan OFF (default)

◇ Monitor action selection “Sq”

The monitor function cuts off the squelch function temporarily. This selection contains PUSH or HOLD settings as shown below.

- PUSH (Pu): After pushing the [SQL•MONI] for 1 sec., the squelch function is cut off until [SQL•MONI] is released. (default)
- HOLD (Ho): After pushing the [SQL•MONI] for 1 sec., the squelch function is cut off continuously until another key is pushed.

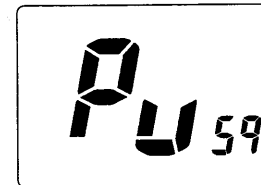

Monitor switch PUSH (default)

◇ Automatic backlighting “bL”

This function is convenient for nighttime operation. The automatic backlighting turns the backlighting ON when pushing any key except for [PTT].

- The backlighting is automatically turned OFF after 5 sec. of inactivity.

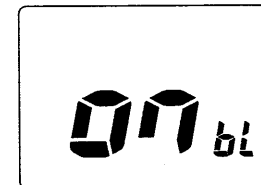

Automatic backlighting ON (default)

◇ **LCD contrast selection** “LC”

The contrast of the LCD can be adjusted from 4 levels.

- 1 (low contrast) – 4 (high contrast); 3 (default)

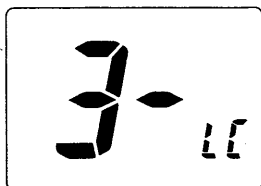

LCD contrast (default)

◇ **Auto power save function** “PS”

The power save function reduces current drain by deactivating the receiver circuit for preset intervals.

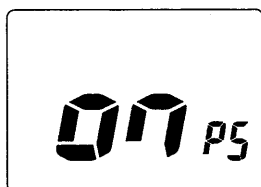

Auto power save ON (default)

◇ **Self check function** “SC”

The self check function checks transceiver conditions by itself, and informs you in case a problem is found. The following items are checked after the power is turned ON, then it switches to operation mode.

- Temperature (Outside of -15°C to +55°C)
- Connected battery voltage
- Water intrusion

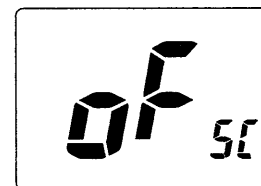

Self check OFF (default)

When error messages as shown below are displayed, see trouble shooting for advice (p. 23).

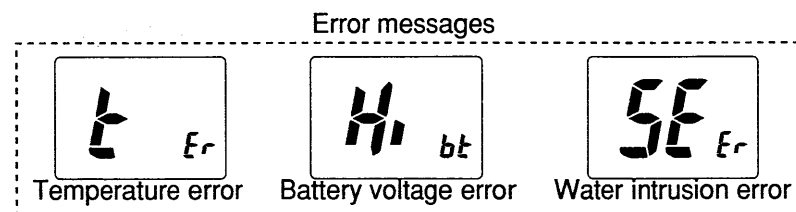

◇ Battery voltage indicator "bt"

This function contains display or non-display settings of the voltage of the connected battery pack when the power is ON.

- The voltage of the connected battery pack is displayed for 2 sec. after power is turned ON.

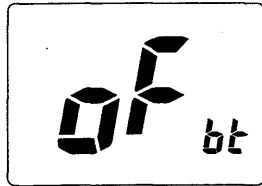

Battery voltage OFF (default)

◇ S-meter/RF meter indicator "Sr"

This function contains display or non-display setting of the S-meter/RF meter.

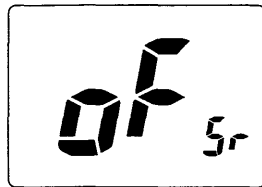

S-meter/RF meter OFF (default)

SET MODE LIST

Function	Indication	Switch
Beep tone	"bP"	OFF / Auto* / 1-10
Scan type selection	"Pr"	OFF / ON*
Scan resume timer	"St"	OFF* / ON
Auto scan function	"AS"	OFF* / ON
Monitor switch selection	"Sq"	Push* / Hold
Automatic backlighting	"bL"	ON* / OFF
LCD contrast selection	"LC"	3* / 1-4
Auto power save function	"PS"	ON* / OFF
Self check function	"SC"	OFF* / ON
Battery voltage indicator	"bt"	OFF* / ON
S-meter/RF meter indicator	"Sr"	OFF* / ON

*default setting

■ Battery charging

Prior to using the transceiver for the first time, the Ni-Cd batteries must be fully charged for optimum life and operation.

CAUTION: To avoid damage to the transceiver, turn it OFF while charging.

- Recommended temperature range for charging:
+10°C to +40°C (+50°F to +104°F)
- Use the supplied charger (BC-150) only. **NEVER** use an other manufactures charger.

 **NEVER** connect DC power to the battery case when installing alkaline batteries. Such a connection will damage the transceiver.

■ Battery cautions

NEVER incinerate used Ni-Cd batteries. Internal battery gas may cause an explosion.

NEVER immerse batteries in water. If the battery case becomes wet, be sure to wipe it dry **BEFORE** attaching it to the transceiver.

NEVER short terminals of the battery case. Also, current may flow into nearby metal objects so be careful when placing battery cases in handbags, etc.

If your Ni-Cd batteries seem to have no capacity even after being charged, completely discharge them by leaving the power ON overnight. Then, fully charge the Ni-Cd batteries again. If the batteries still do not retain a charge (or very little), new batteries must be purchased.

■ Optional battery chargers

◇ Rapid charging with the BC-119N+AD-103

The optional BC-119N provides rapid charging of battery packs. The following are additionally required.

- AD-103
- An AC adapter (may be supplied with BC-119N depending on version).

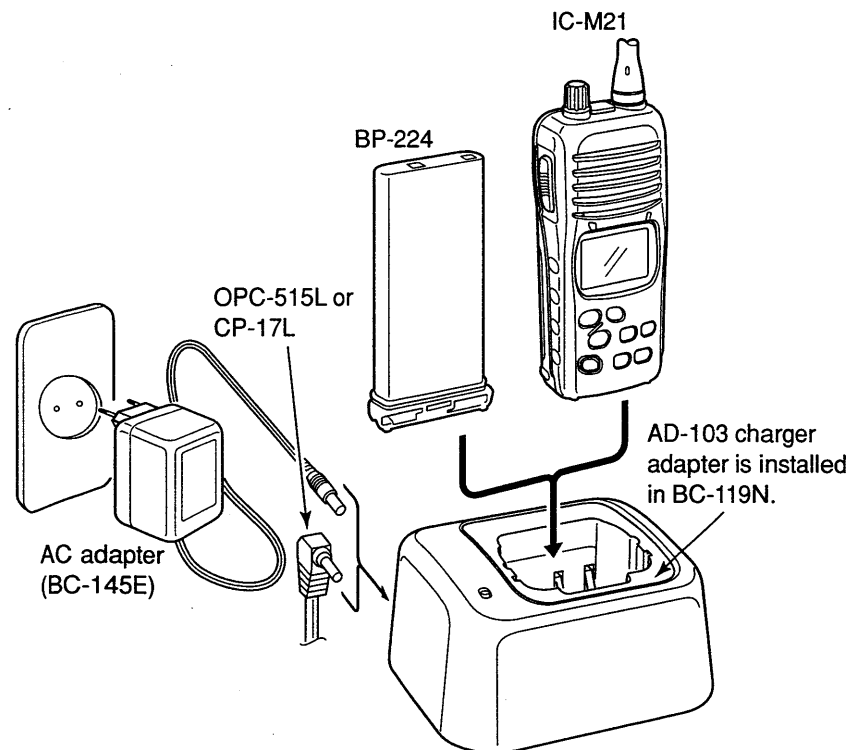

◇ Rapid charging with the BC-121N+AD-103

The optional BC-121N allows up to 6 battery packs to be charged simultaneously. The following are additionally required.

- Six AD-103.
- An AC adapter (BC-124) or the DC power cable (OPC-656).

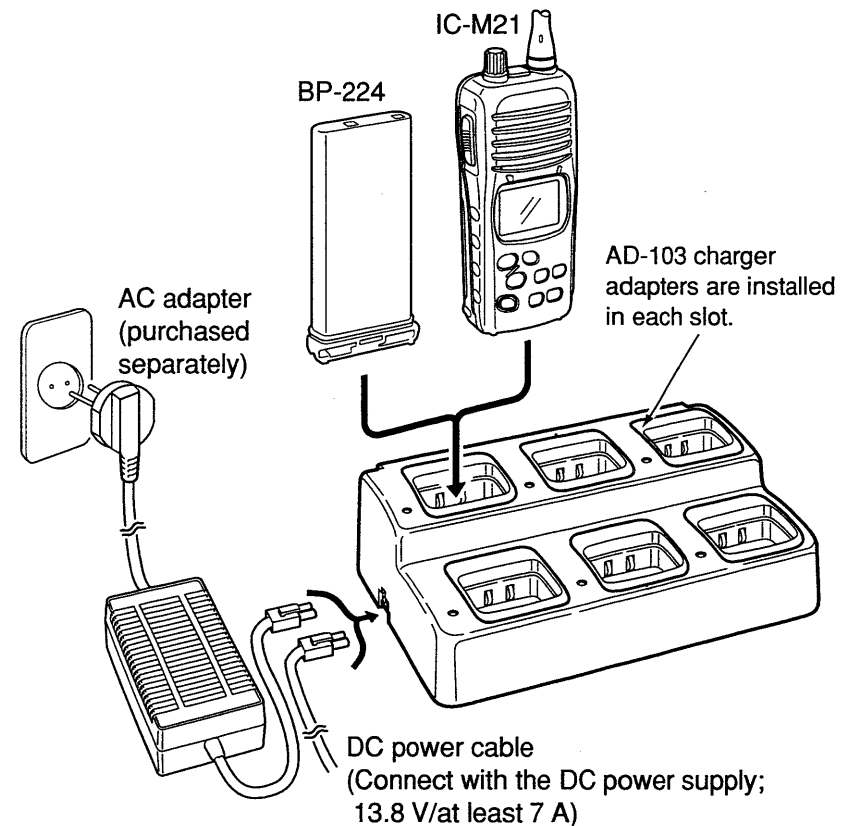

◆ Charging connections

- ① Attach the BC-150 to a flat surface, such as desk or cabin, etc., if desired.
- ② Connect the AC adapter (BC-147E) as shown below.
- ③ Insert the battery pack with/without the transceiver into the charger.
 - The charge indicator lights green.
- ④ Charge the battery pack approx. 8 hours, depending on the remaining power condition.

CAUTION: DO NOT charge BP-224 more than 12 hours. Otherwise, BP-224 will be damaged. BP-224 must be charged for 8–12 hours only.

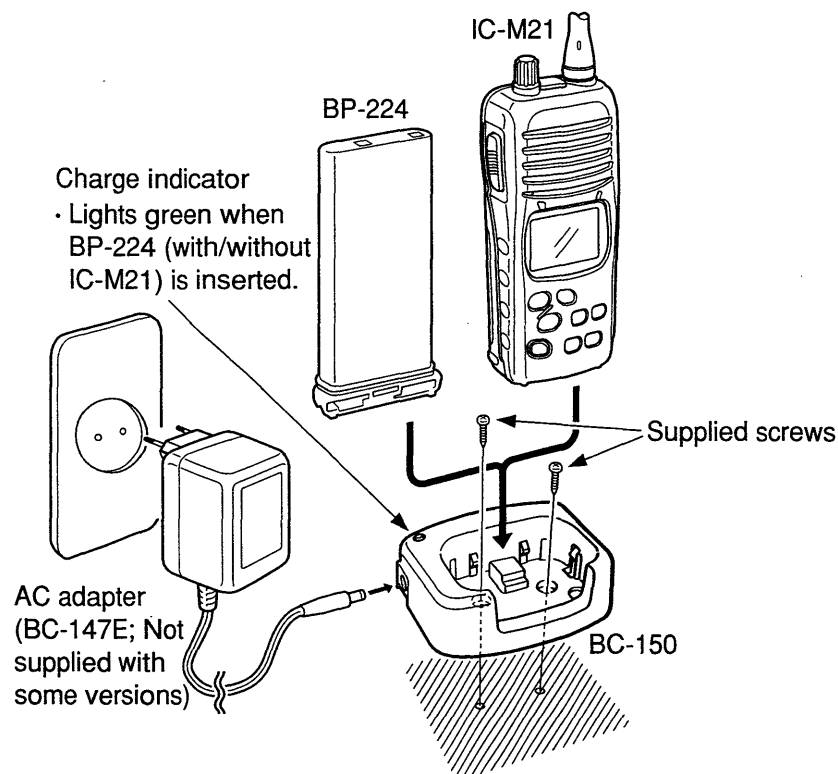

■ Installing batteries in the battery case (Not supplied with some versions)

When using a battery case attached to the transceiver, install 6 × AA(R6) size alkaline batteries as illustrated below.

- ① Remove the battery case from the transceiver.
- ② Install 6 × AA(R6) size alkaline batteries.
 - Be sure to observe the correct polarity.

CAUTION:

- When installing batteries, make sure they are all the same brand, type and capacity. Also, do not mix new and old batteries together.
- Keep battery contacts clean. It's a good idea to clean battery terminals once a week.

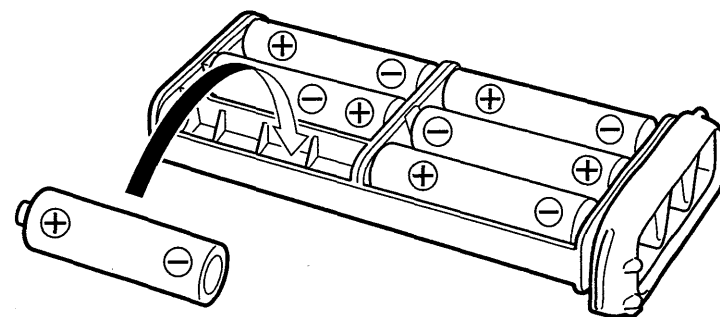



◇ Supplied accessories

The following accessories are supplied:

Qty.

- | | |
|-------------------------------------|---|
| ① Flexible antenna | 1 |
| ② Swivel belt clip | 1 |
| ③ Handstrap | 1 |
| ④ Battery case (BP-223)* | 1 |
| ⑤ Ni-Cd battery pack (BP-224) | 1 |
| ⑥ AC adapter (BC-147E)* | 1 |
| ⑦ Battery charger (BC-150) | 1 |
| ⑧ Screws for the BC-150 (M3.5 × 20) | 2 |

* Not supplied with some versions.

◇ Flexible antenna

Connect the supplied flexible antenna to the antenna connector.

CAUTION: Transmitting without an antenna may damage the transceiver.

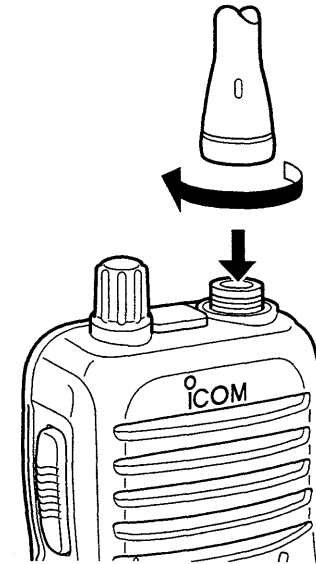

◇ Handstrap

Slide the handstrap through the loop on the side of the transceiver as illustrated at right. Facilitates carrying.

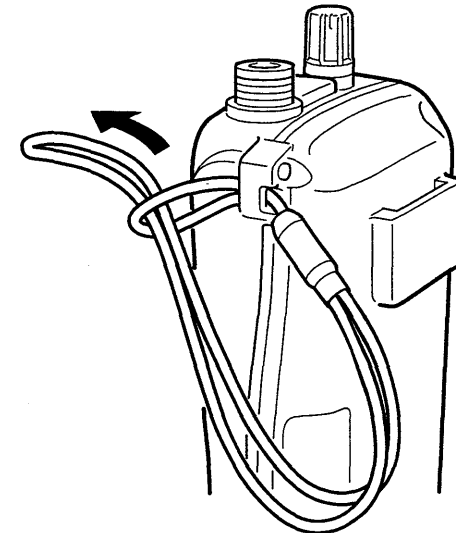

◆ Swivel belt clip

To attach:

① Slide the stopper into the plastic loop on the back of the transceiver.

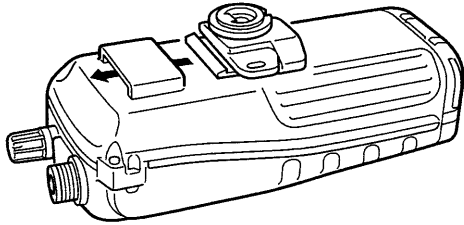

② Clip the belt clip to a part of your belt.

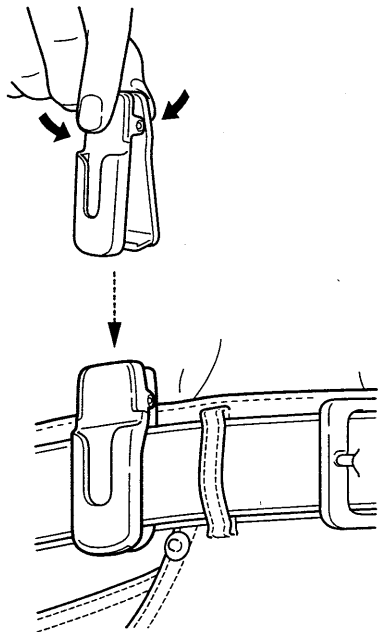

③ Insert the stopper to the back of the belt clip.

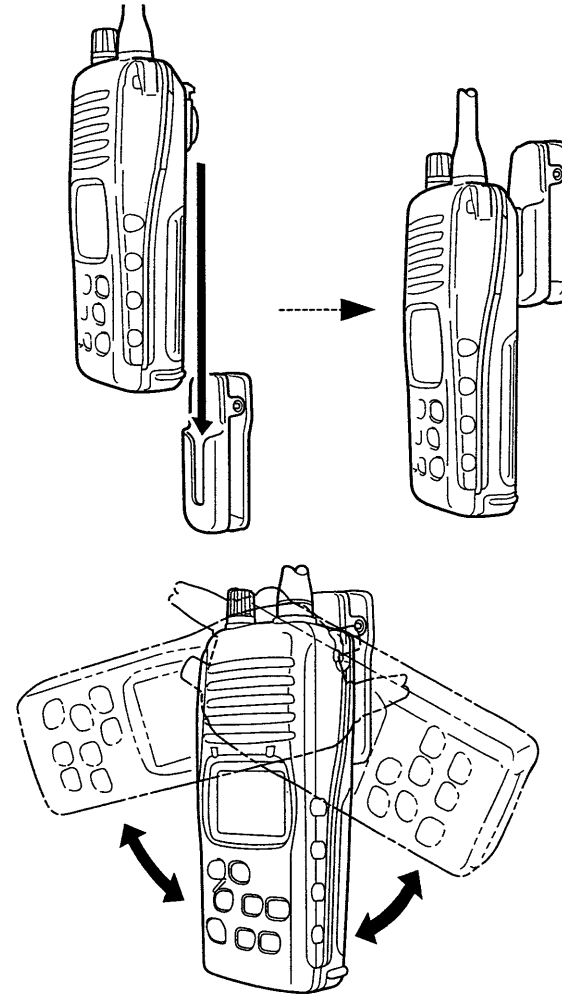

Once the transceiver is locked in place, it will swivel 360 degrees.

To remove:

- ① Turn the transceiver upside down, and then lift to release the transceiver from the belt clip.

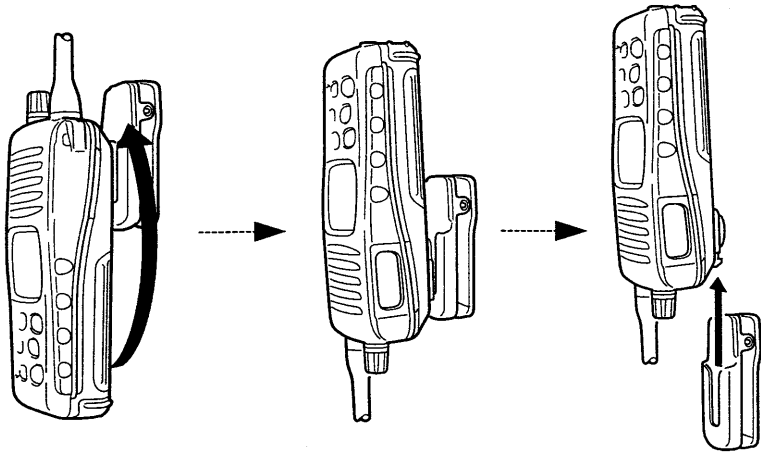

⚠ CAUTION!

HOLD THE TRANSCEIVER TIGHTLY, WHEN ATTACHING OR REMOVING THE TRANSCEIVER FROM THE BELT CLIP.

If the transceiver is accidentally dropped and the swivel belt clip's stopper is scratched or damaged, the swivel belt clip may not work properly.

- ② Release the belt clip.

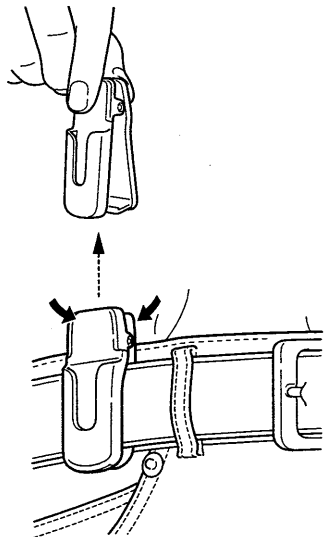

- ③ Push the top of the stopper towards the transceiver and out at the same time, then push it downwards and free of the plastic loop.

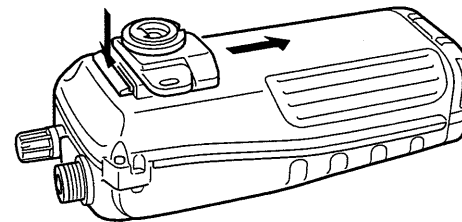

PROBLEM	POSSIBLE CAUSE	SOLUTION	REF.
No power comes ON.	<ul style="list-style-type: none"> • The battery is exhausted. • Bad connection to the battery pack. 	<ul style="list-style-type: none"> • Recharge the battery pack. • Check the connection to the transceiver. 	<p>p. 17</p> <p>p. 3</p>
No sound comes from the speaker.	<ul style="list-style-type: none"> • Squelch level is too deep. • Volume level is too low. • Speaker has been exposed to water. 	<ul style="list-style-type: none"> • Set squelch to the threshold point. • Set [OFF/VOL] to a suitable level. • Drain water from the speaker. 	<p>p. 7</p> <p>p. 8</p> <p>—</p>
Transmitting is impossible, or high power can not be selected.	<ul style="list-style-type: none"> • Some channels are for low power or receive only. • The battery is exhausted. • The output power is set to low. 	<ul style="list-style-type: none"> • Change channels. • Recharge the battery pack. • Push [H/L] to select high power. 	<p>pgs. 2, 4</p> <p>p. 17</p> <p>p. 2</p>
The display channel cannot be changed.	<ul style="list-style-type: none"> • Lock function is activated. 	<ul style="list-style-type: none"> • Push [H/L•LOCK] for 1 sec. to cancel the function. 	p. 2
Scan does not start.	<ul style="list-style-type: none"> • "TAG" channels are not programmed. 	<ul style="list-style-type: none"> • Set the desired channels as "TAG" channels. 	p. 12
No beeps sound.	<ul style="list-style-type: none"> • Beep tones are turned OFF. 	<ul style="list-style-type: none"> • Set the beep tones to AUTO or 1–10 in SET mode. 	p. 13
Self check error. (Temperature error)	<ul style="list-style-type: none"> • Transceiver's inside temperature is below -20°C (-4°F) or above $+60^{\circ}\text{C}$ ($+120^{\circ}\text{F}$). 	<ul style="list-style-type: none"> • Leave the transceiver at room temperature for a while. Turn the power ON to check if the internal temperature has returned to normal. 	—
Self check error. (Battery voltage error)	<ul style="list-style-type: none"> • The connected battery pack's voltage is more than 11 V. 	<ul style="list-style-type: none"> • Verify the battery voltage is correct. 	—
Self check error. (Water intrusion error)	<ul style="list-style-type: none"> • Water has entered the transceiver. 	<ul style="list-style-type: none"> • Have the transceiver checked at your local distributor or dealer to see whether the transceiver works properly or not. 	—

• International channels

CH	Frequency (MHz)		CH	Frequency (MHz)		CH	Frequency (MHz)		CH	Frequency (MHz)		CH	Frequency (MHz)		CH	Frequency (MHz)	
	Transmit	Receive		Transmit	Receive		Transmit	Receive		Transmit	Receive		Transmit	Receive		Transmit	Receive
01	156.050	160.650	11	156.550	156.550	21	157.050	161.650	62	156.125	160.725	72	156.625	156.625	82	157.125	161.725
02	156.100	160.700	12	156.600	156.600	22	157.100	161.700	63	156.175	160.775	73	156.675	156.675	83	157.175	161.775
03	156.150	160.750	13	156.650	156.650	23	157.150	161.750	64	156.225	160.825	74	156.725	156.725	84	157.225	161.825
04	156.200	160.800	14	156.700	156.700	24	157.200	161.800	65	156.275	160.875	75†	156.775	156.775	85	157.275	161.875
05	156.250	160.850	15†	156.750	156.750	25	157.250	161.850	66	156.325	160.925	76†	156.825	156.825	86	157.325	161.925
06	156.300	156.300	16	156.800	156.800	26	157.300	161.900	67	156.375	156.375	77	156.875	156.875	87	157.375	157.375
07	156.350	160.950	17†	156.850	156.850	27	157.350	161.950	68	156.425	156.425	78	156.925	161.525	88	157.425	157.425
08	156.400	156.400	18	156.900	161.500	28	157.400	162.000	69	156.475	156.475	79	156.975	161.575			
09	156.450	156.450	19	156.950	161.550	60	156.025	160.625	70	Rx only	156.525	80	157.025	161.625			
10	156.500	156.500	20	157.000	161.600	61	156.075	160.675	71	156.575	156.575	81	157.075	161.675			

• USA channels (for U.K. version only)

CH	Frequency (MHz)		CH	Frequency (MHz)		CH	Frequency (MHz)		CH	Frequency (MHz)		CH	Frequency (MHz)		CH	Frequency (MHz)	
	Transmit	Receive		Transmit	Receive		Transmit	Receive		Transmit	Receive		Transmit	Receive		Transmit	Receive
01A	156.050	156.050	12	156.600	156.600	22A	157.100	157.100	64A	156.225	156.225	77	156.875	156.875	86	157.325	161.925
--	---	---	13†	156.650	156.650	23A	157.150	157.150	65A	156.275	156.275	78A	156.925	156.925	86A	157.325	157.325
03A	156.150	156.150	14	156.700	156.700	24	157.200	161.800	66A	156.325	156.325	79A	156.975	156.975	87	157.375	161.975
--	---	---	15†	156.750	156.750	25	157.250	161.850	67†	156.375	156.375	80A	157.025	157.025	87A	157.375	157.375
05A	156.250	156.250	16	156.800	156.800	26	157.300	161.900	68	156.425	156.425	81A	157.075	157.075	88	157.425	162.025
06	156.300	156.300	17†	156.850	156.850	27	157.350	161.950	69	156.475	156.475	82A	157.125	157.125	88A	157.425	157.425
07A	156.350	156.350	18A	156.900	156.900	28	157.400	162.000	70	Rx only	156.525	83A	157.175	157.175			
08	156.400	156.400	19A	156.950	156.950	37A	157.850	157.850	71	156.575	156.575	84	157.225	161.825			
09	156.450	156.450	20	157.000	161.600	61A	156.075	156.075	72	156.625	156.625	84A	157.225	157.225			
10	156.500	156.500	20A	157.000	157.000	--	---	---	73	156.675	156.675	85	157.275	161.875			
11	156.550	156.550	21A	157.050	157.050	63A	156.175	156.175	74	156.725	156.725	85A	157.275	157.275			

†Low power only.

■ Specifications

• GENERAL

Frequency coverage	: Transmit 156.000–161.450 MHz
	Receive 156.000–163.425 MHz
Mode	: FM (16K0G3E)
Channel spacing	: 25 kHz
Current drain (at 7.5 V DC)	: TX High (5 W) 1.5 A typical
	(1 W) 0.7 A typical
	Max. audio 200 mA typical
	Power save 20 mA typical
Frequency stability	: ±1.5 kHz (–15°C to +55°C)
Operating temperature range	: –15°C to +55°C
Dimensions	: 61 (W) × 135(H) × 41(D) mm
(Projections not included)	2 ¹³ / ₃₂ (W) × 5 ⁵ / ₁₆ (H) × 1 ⁵ / ₈ (D) inch
Weight (approx.; with BP-224)	: 360g (12.7 oz)

• TRANSMITTER

Output power (at 7.5 V DC)	: 5 W (Hi), 3 W (Mid), 1 W (Low) or 1 W (Hi), 0.5 W (Low) <(#07)FRG>
Modulation system	: Variable reactance frequency modulation
Max. frequency deviation	: ±5 kHz
Audio harmonics distortion	: Less than 10 % (at 60 % mod.)
Spurious emissions	: Less than 0.25 μW

• RECEIVER

Receive system	: Double-conversion superheterodyne
Sensitivity (20 dB SINAD)	: Less than –2 dBμ EMF (typical)
Squelch sensitivity (at threshold)	: Less than 0 dBμ EMF (typical)
Intermodulation rejection ratio	: 68 dB
Spurious response rejection ratio	: 70 dB
Adjacent channel selectivity	: 70 dB
Hum and noise ratio	: More than 40 dB
Audio output power	: 0.2 W typical at 10% distortion with an 8 Ω load

All stated specifications are subject to change without notice or obligation.

■ Options

◇ BATTERY CASE AND PACK

• BP-223 BATTERY CASE

Battery case for 6 × AA (R6) alkaline cells. The same as supplied with the transceiver depending on versions.

• BP-224 Ni-Cd BATTERY PACK

7.2 V/750 mAh Ni-Cd battery pack. The same as supplied with the transceiver depending on versions.

◇ CHARGERS

• BC-119N DESKTOP CHARGER + AD-103 CHARGER ADAPTER + BC-145 AC ADAPTER

For rapid charging of battery packs. An AC adapter is supplied with the charger. Charging time: approx. 1.5 to 2 hours

• BC-121N MULTI-CHARGER + AD-103 CHARGER ADAPTER (6 pcs.) + BC-124 AC ADAPTER

For rapid charging of up to 6 battery packs (six AD-103's are required) simultaneously. An AC adapter may be supplied depending on version. Charging time: approx. 1.5 to 2 hours.

• BC-150 DESKTOP CHARGER + BC-147E AC ADAPTER

Used for regular charging of battery pack. The same as supplied with the transceiver. Charging time: approx. 8 hours

◇ BELT CLIPS

• MB-68 BELT CLIP

Universal belt clip for attaching to your belt.

• MB-74 BELT CLIP

Exclusive alligator-type belt clip.

• MB-87 SWIVEL BELT CLIP

Belt clip for swivel type. The same as supplied with the transceiver.



< Intended Country of Use >

- | | | | |
|------------------------------|------------------------------|------------------------------|------------------------------|
| <input type="checkbox"/> GER | <input type="checkbox"/> NED | <input type="checkbox"/> ITA | <input type="checkbox"/> AUT |
| <input type="checkbox"/> BEL | <input type="checkbox"/> GRE | <input type="checkbox"/> GBR | <input type="checkbox"/> LUX |
| <input type="checkbox"/> SWE | <input type="checkbox"/> IRL | <input type="checkbox"/> ESP | <input type="checkbox"/> DEN |
| <input type="checkbox"/> FRA | <input type="checkbox"/> POR | <input type="checkbox"/> FIN | <input type="checkbox"/> SUI |
